

FREE STANDING MIXER

- 1** PLEASE CHECK TO MAKE SURE NO PIECES ARE MISSING. CONTACT YOUR LOCAL DISTRIBUTOR IF THERE ANY MISSING PARTS.

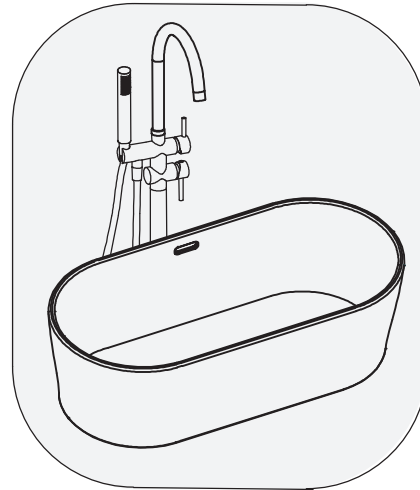

SEE THE DRAWINGS AS BELOW:

No	Name	Quantity
1	body assembly	1
2	straight tube	1
3	inlet pipe	2
4	escutcheon	1
5	embedded box	1
6	hand shower	1
7	shower hose	1
8	gloves	1
9	instructions	1
10	hexagon screw	1

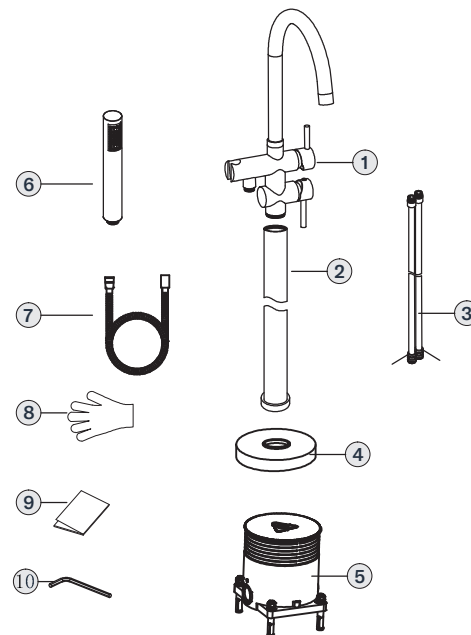

- 2** TO GUARANTEE THE CORRECT FUNCTIONING AND WATER FLOW, MAKE SURE THAT THE PIPES HAVE BEEN FLUSHED CORRECTLY, REMOVING ALL RESIDUES OF MUD AND SAND.

- 3** THE HEIGHT OF YOUR BATH SHOULD MATCH WITH THE DIMENSION OF OUR FREE STANDING FAUCET.

1 OPEN THE EMBEDDED BOX COVER.

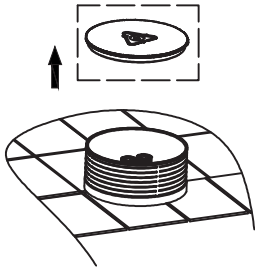

2 REMOVE THE PLATE AND PLUG USING THE HEXAGON SCREW.

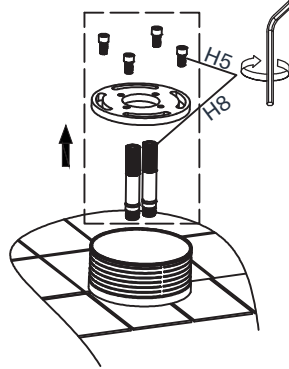

3 USING A CUTTER CUT AROUND THE BOX SO THAT IT IS FLUSH WITH THE SURFACE.

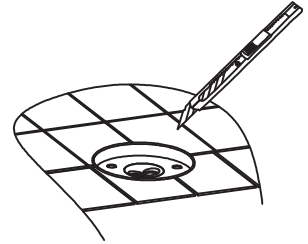

4 INSTALL THE ESCUTCHEON TO THE UPPER PART OF THE TUBE; CONNECT THE INLET PIPES TO THE BODY USING THE HEXAGON SCREW.

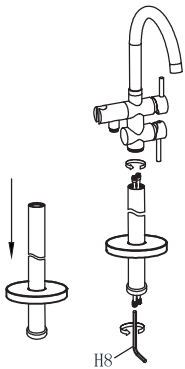

5 CONNECT THE STRAIGHT TUBE TO THE BODY.

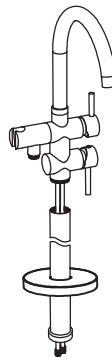

6 CONNECT THE PLATE TO THE TUBE USING THE HEXAGON SCREW.

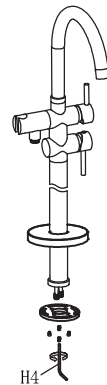

7 CONNECT THE INLET PIPES OF THE EMBEDDED BOX; ADJUST THE POSITION OF THE SPOUT AND BATH; CONNECT THE PLATE INTO THE EMBEDDED BOX THROUGH THE PLATE SCREWS.

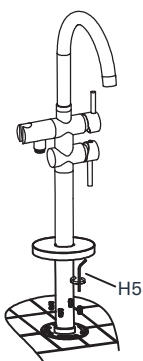

8 INSTALL THE HAND SHOWER AND SHOWER HOSE.

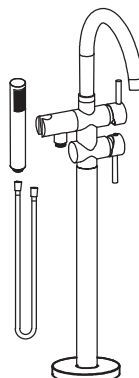

9 TOTAL ASSEMBLY PICTURE.

